



RainPoint[®] Smart
More Than Water Saving

USER MANUAL

Soil & Moisture Sensor

Model No. HCS021FRF-DLS

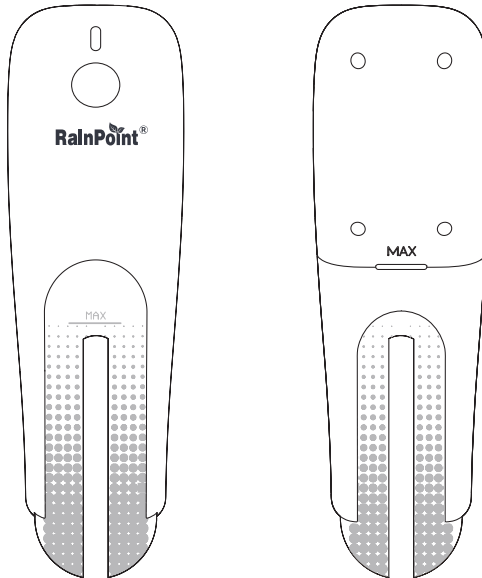

Welcome to the **RAINPOINT** family! Please read the manual before using to learn about the features and functions.

Contents

1.	Contents in the box	01
2.	Introduction	02
	2.1 Product Overview	02
	2.2 Specification	03
	2.3 Product Features	03
3.	Connection and Installation	03
	3.1 Sensor Connection	04
	3.2 Sensor Installation	07
4.	App Features and Functions	09
	4.1 Device Home Page	09
	4.2 Basic Setting	10
	4.3 Soil Type	10
	4.4 Charts	11
5.	Trouble Shooting	12
6.	Precautions	13
7.	Warranty Policy	13
8.	FCC Statement	14
9.	Customer Support	15

1. Contents in the box

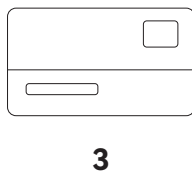
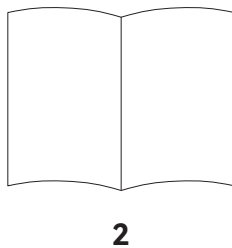
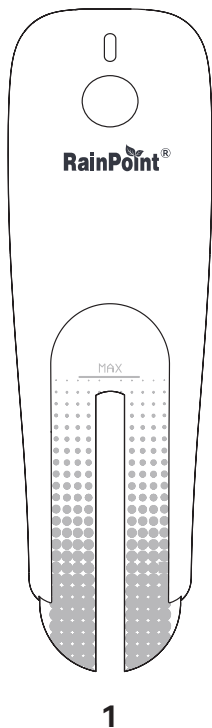

1. HCS021FRF-DLS Soil & Moisture Sensor
2. User Manual
3. Warranty Card

2. Introduction

2.1 Product Overview

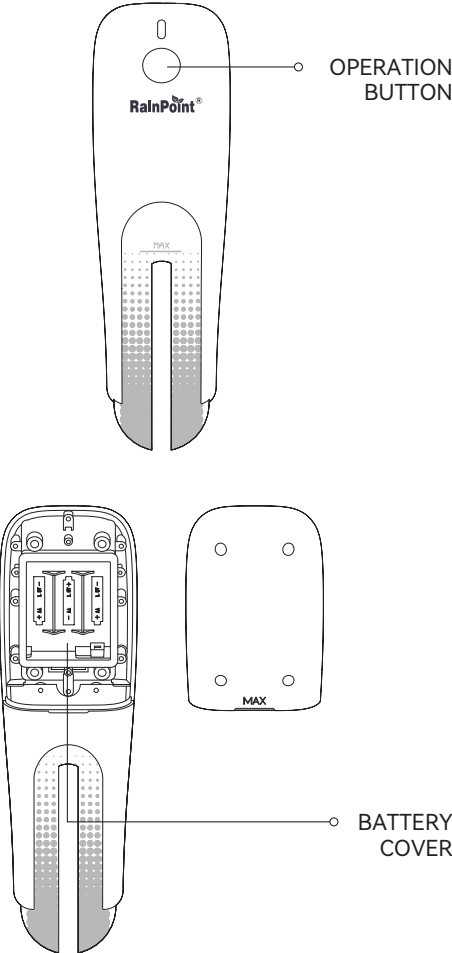

2.2 Specification

- **Waterproof Level:** IPX5
- **Temperature Range:** -4°F-140°F(-20°C-60°C)
- **Humidity Range:** 0%-100% RH
- **Light Intensity:** 0-200,000 lux
- Communicated by Wi-Fi 2.4GHz.
- Up to 60m depending on obstacle between hub and timer
- Powered by 3* AA batteries (Not included)

2.3 Product Features

- Measures soil moisture (%) and surface temperature (°C/°F).
- Built in light sensor at the top to monitor light intensity.
- App remote controlled, easy to set up and operate.
- Pair with water timers, efficient and accurate irrigation.
- Appropriate and modern mold design, accurate measurement.
- Use for outdoor gardening, learn more about areas of soil information.
- Choose different soil type.

3. Connection And Installation



Tips: Please scan the QR code or search the link to access the video to connect the device quickly and easily.

Set Video: <http://bit.ly/3jIwZle>

3.1 Sensor Connection

This device is a sub-device, please connect the hub of Rainpoint Smart* series before connecting this device.

1. Select the **+** button on the top right corner of the APP home page to add device, or you can go to the hub's home page and use "**Sub-devices**" to add devices.

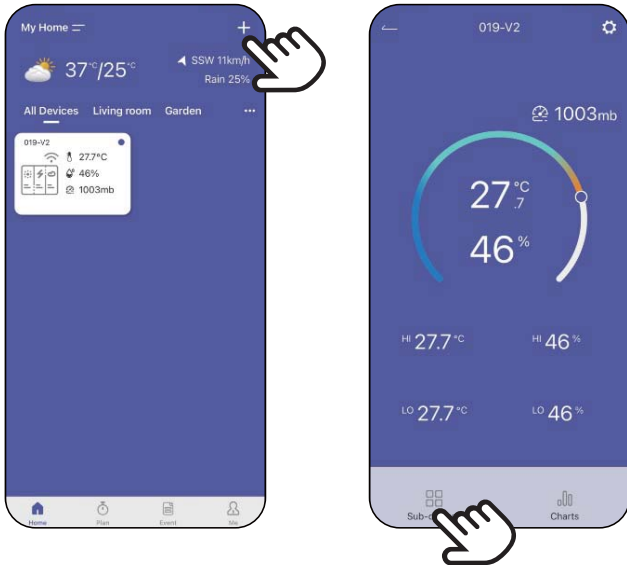

2. Find " **Soil Moisture Sensor** " or the icon  to add the sensor.

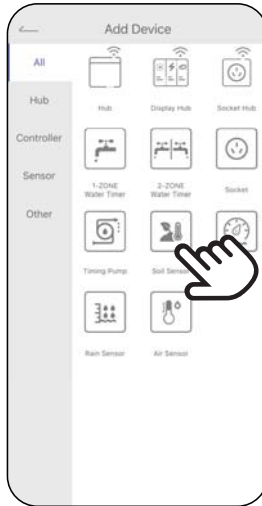

3. Inset the batteries, and then the indicator will quickly blink in red.

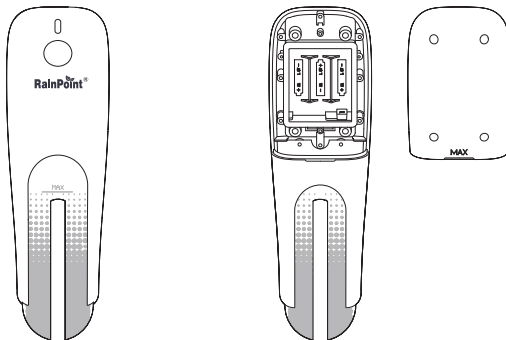

Tips: Use the tool to unscrew the four screws of the back cover.

4. Keep the sensor and the hub close to each other to connect automatically. (Besides that, you can also hold the button to reset and reconnect if you fail to connect for the first time.)



5. After successfully connecting, the real-time surface temperature, soil moisture, and light intensity will display on the device home page.



3.2 Sensor Installation

1. Insert the batteries and tighten the screw.

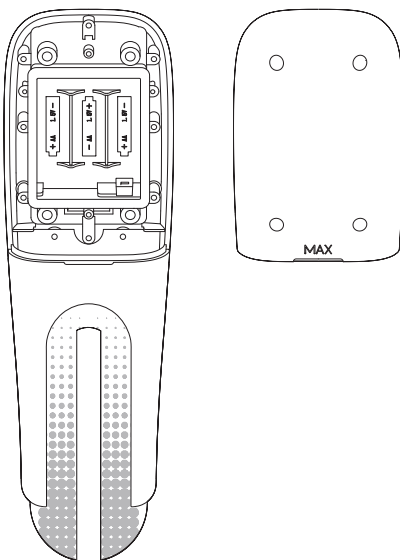

2. Dig an appropriate hole that can completely bury the soil probe.

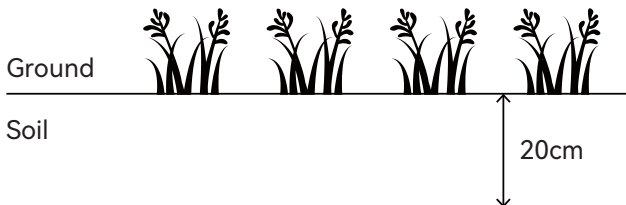

3. Bury the sensor in the soil and ensure that the sensor is vertically downward.

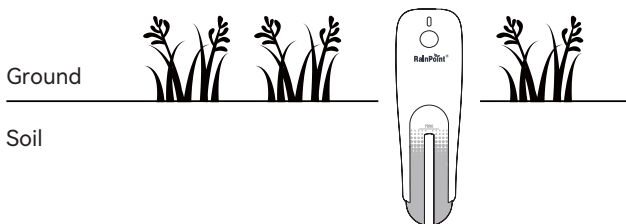

Tips: For accuracy, make sure that the part of the soil probe marked below "MAX" is buried in the soil.

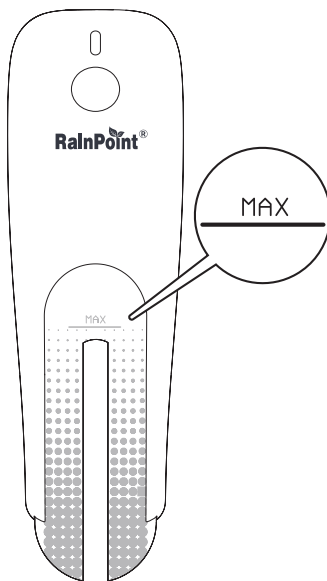

4. APP Features And Functions

4.1 Device Home Page

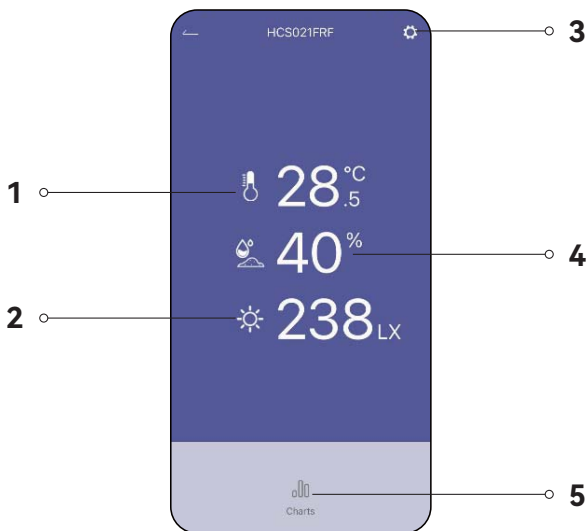

1. **Surface Temperature**
2. **Light Intensity**
3. **Setting:** Basic settings for the sensor.
4. **Soil Moisture**
5. **Charts:** Check the past 24 hours, and 10 days' historical temperature, moisture, and light intensity.

4.2 Basic Setting

Find the icon  on the top right corner of the APP home page to "Settings" page. In the basic settings, you can check and manage the device information, such as name, interface and description.



4.3 Soil Types

Choose the soil type according to the soil of your home.

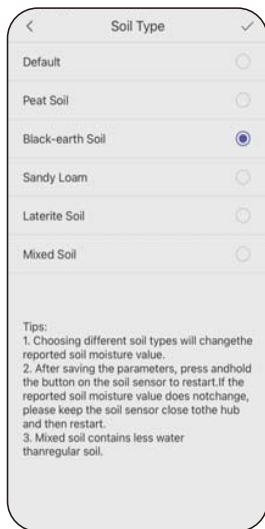

4.4 Charts

Select Charts to review your soil moisture, surface temperature, and light intensity in the past 24 hours, and 10 days in a line graph. Press the top right corner to switch moisture, temperature, and light intensity.



5. Trouble Shooting

Problem	Possible Factors	Solution may help
Fail to connect with the hub	<ul style="list-style-type: none">• Wi-Fi signal unstable.• Distance between sensor and hub is too far.	<ul style="list-style-type: none">• Wait a little bit and try to connect one more time by holding the button.• Stay close to the hub while connecting.
Lose connection or get offline on the APP	<ul style="list-style-type: none">• Low battery.• Hub disconnected.• Wi-Fi signal unstable.	<ul style="list-style-type: none">• Take the soil out of the soil and change brand new batteries.• Check the hub and reconnect it if disconnected. Then hold the button on the sensor to reconnect.• Wait a little bit and try to connect one more time by holding the button.
Data inaccurate or incorrect	Stones around the sensor.	Please make sure no stones around the sensor while bury it to avoid stones affect accuracy.
If you need more help about the product or anything from us, please contact us by Email: support@rainpointonline.com		

6. Precautions

- Must tighten the screws before installing.
- Do not mix old and new batteries or different types of batteries.
- Under freezing temperatures, please keep the sensor away from snow to avoid potential freezing damage.
- Do not force the product into the soil, please follow the installation guide.

7. Warranty Policy

RAINPOINT provides a 1-year limited warranty on this product against manufacturing defects in materials and workmanship.

8. FCC STATEMENT

This device complies with Part 15 of the FCC Rules. Operation is subject to the following two conditions:

1. This device may not cause harmful interference.
2. This device must accept any interference received, including interference that may cause undesired operation.

FCC Warning: Any changes or modifications not expressly approved by the party responsible for compliance could void the user's authority to operate this equipment.

Note: This equipment has been tested and found to comply with the limits for a Class B digital device, pursuant to Part 15 of the FCC Rules. These limits are designed to provide reasonable protection against harmful interference in a residential installation. This equipment generates, uses, and can radiate radio frequency energy, if not installed and used in accordance with the instructions, may cause harmful interference to radio communications. However, there is no guarantee that interference will not occur in a particular installation. If this equipment does cause harmful interference to radio or television reception, which can be determined by turning the equipment off and on, the user is encouraged to try to correct the interference by one of the following measures:

- Reorient or relocate the receiving antenna.
- Increase the separation between the equipment and the receiver.
- Connect the equipment into an outlet on a circuit different from that to which the receiver is connected.
- Consult the dealer or an experienced radio/TV technician for help.

Note: The manufacturer is not responsible for any radio or TV interference caused by unauthorized modifications to this equipment. Such modifications could void the user's authority to operate the equipment.

9. Customer Support

If you find it difficult to set up and want to watch the setting tutorial video, please subscribe to our channel RainPoint on YouTube.



Or scan the QR code to visit the RainPoint channel on YouTube quickly.

If the app and the user manual don't have what you're looking for, and need some help about Rainpoint, please contact us by

LOT NO.: XXXXX (on the back of the device)



Made in China



Not included



Points de collecte sur www.quefairedemesdechets.fr
Privilégiez la réparation ou le don de votre appareil !

Need Help ?

Scan the QR code for more help.



or Email:

support@rainpointonline.com