

HydroSure™

IRRIGATION SYSTEMS THAT WORK

Micro 15m Drip Line Irrigation System

(4mm Internal / 6mm External)

15m Micro Drip Pipe & 10m Micro Pipe

www.hydrosure.com

DRIPLINEMICRO-INSTRUCTION



5 056287 722437 >

PLANNING

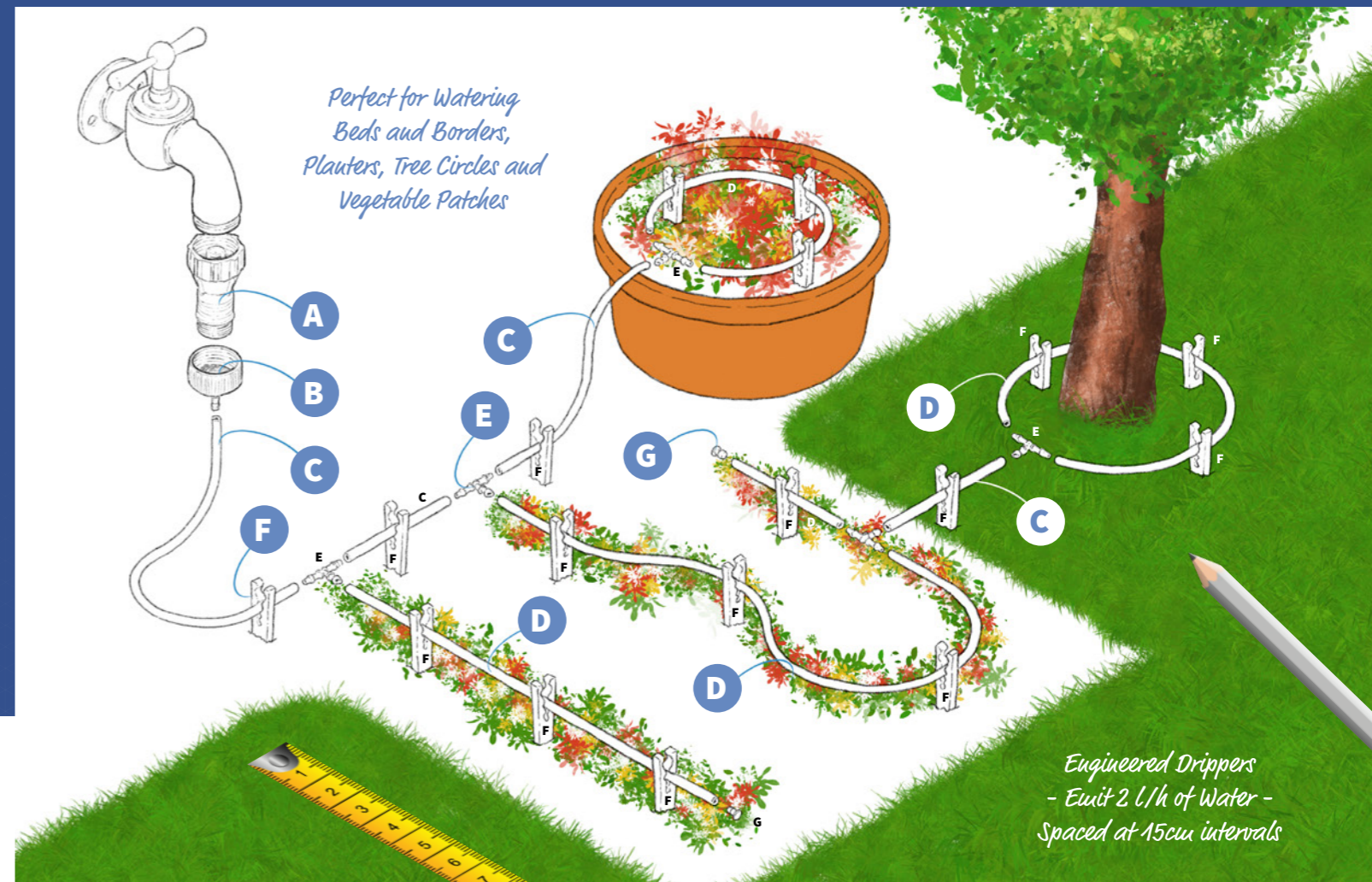

COMPONENTS INCLUDED

A x1	B x1	C x1	D x1
E x10	F x25	<p>Things you might need</p>	
G x20			

INSTALLATION

Icons for tools: measuring tape, scissors, hot water (H₂O).

Icons for components: A, B, C, E, F, G.

Final step icon: thumbs up.

HELPFUL HINTS

UNRAVEL

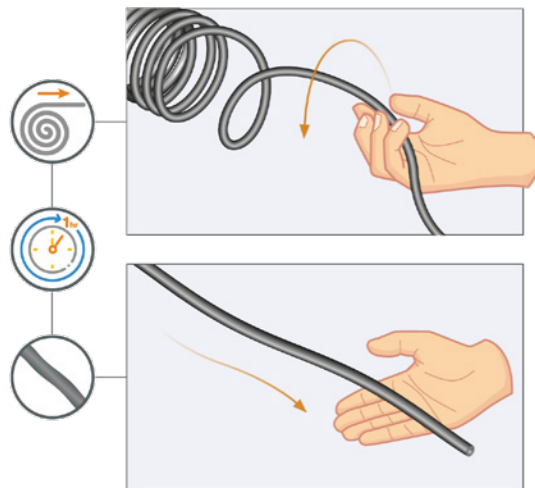
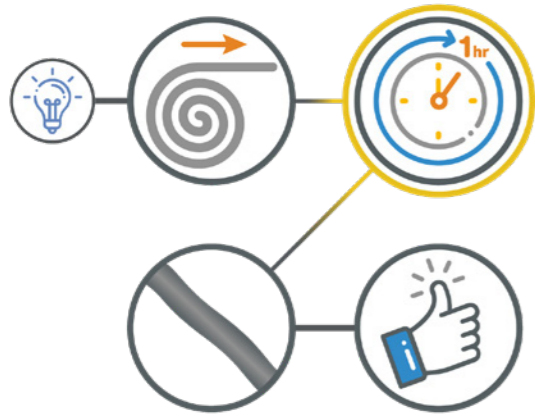

INSTALLATION



FLUSHING SYSTEM

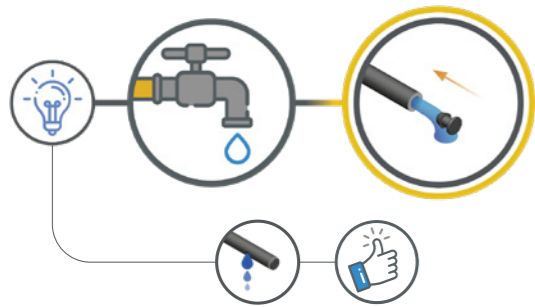

HOLE PUNCHING

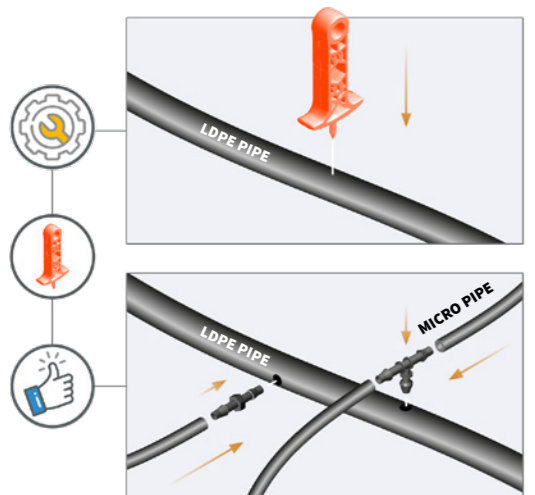

WINTERISING

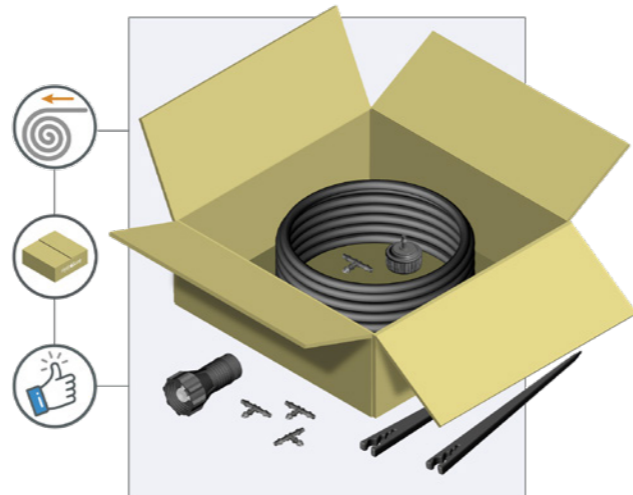
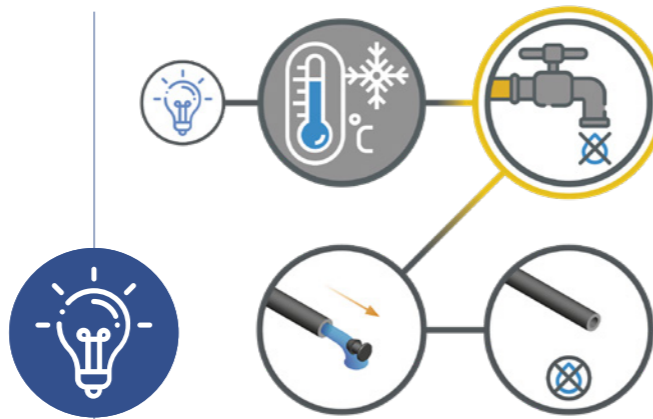

ADDITIONAL EQUIPMENT

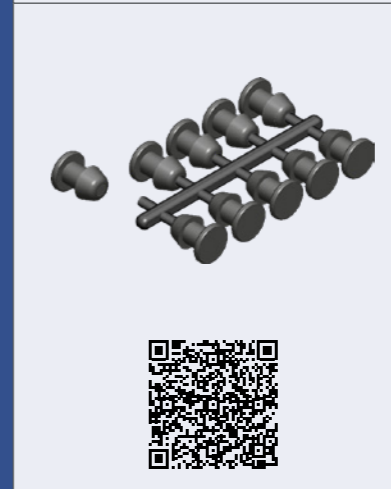

EXTEND YOUR SYSTEM



HydroSure™

IRRIGATION SYSTEMS THAT WORK