

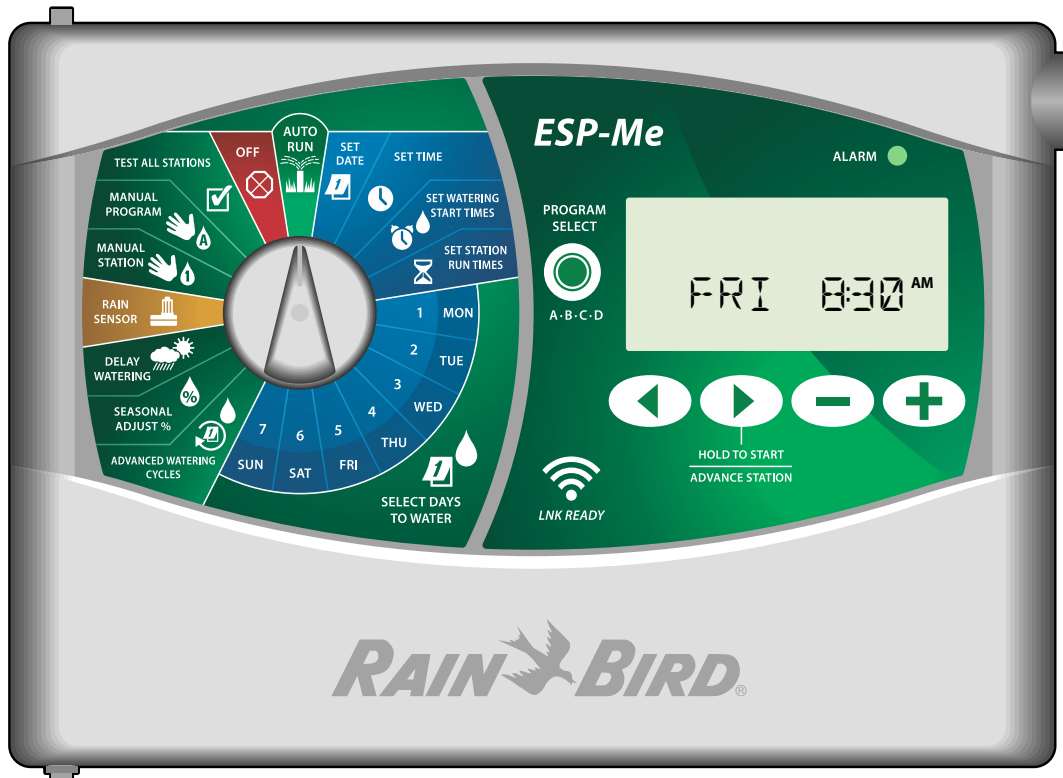

ESP-Me Controller User Manual



 **LNK™ Ready** *sold separately

ESP-Me Controller User Manual

Technical Support.....	ii
Introduction.....	1
Welcome to Rain Bird.....	1
The Intelligent Use of Water®	1
ESP-Me Controller Features	1
WiFi Enabled.....	1
Installation	2
Mount Controller	2
Wiring Connections.....	2
Connect Valves	2
Connect Master Valve (optional).....	2
Connect Pump Start Relay (optional).....	3
Connect Rain/Freeze Sensor (optional).....	3
Connect Power	4
Station Expansion Modules	4
Install Modules	5
Station Numbering	5
Module Configuration	5
Complete Controller Installation	5
Normal Operation	6
Controls and Indicators	6
AUTO RUN	6
OFF.....	6
Program-Based Scheduling	7
Program Stacking	7
Common Programming Error	7
Basic Programming	8
1. Set Date and Time	8
2. Set Watering Start Times	8
3. Set Station Run Times	8
4. Set Watering Days	8
Custom Days of the Week.....	8
Manual Watering Options.....	8
Test All Stations.....	8
Run a Single Station	9
Run a Single Program	9
Advanced Programming	9
Odd or Even Calendar Days	9
Cyclic Days.....	9
Rain Sensor	10
Seasonal Adjust.....	10
Delay Watering	10
Permanent Days Off	10
Total Run Time Calculator By Program	11
Special Features	11

Options	12
Reset Button	12
Remote Accessories.....	12
Remote Programming	12
Battery Life.....	12
Troubleshooting	13
Error Detection.....	13
Programming Errors (blinking LED)	13
Electrical Errors (non-blinking LED)	13
Clearing Electrical Error Alarms	13
Watering Issues	13
Electrical Issues (solid LED illuminated)	14
Safety Information.....	15

Technical Support

Questions?

For help setting up and operating the Rain Bird ESP-Me Controller, scan the QR code to visit

www.rainbird.com/espme



Additional user documentation is available under the Manuals & Literature tab, including:

- User Manual (this document)
- Quick Reference Guide
- Programming Guide
- Foreign Language Support

To learn more about Rain Bird irrigation systems and our Rain Bird Academy training programs, visit:

www.rainbirdsolutions.com/training

To see instructional videos for the ESP-Me, visit

www.youtube.com/

Or call Rain Bird toll free Technical Support at **1-800-724-6247** (USA and Canada only)

Introduction

Welcome to Rain Bird

Thank you for choosing Rain Bird's ESP-Me controller. In this manual are step by step instructions for how to install and operate the ESP-Me.

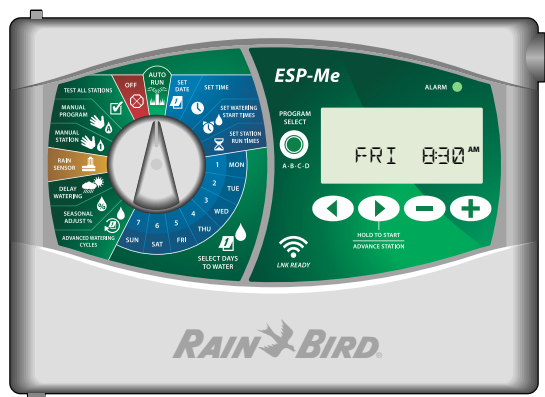

The Intelligent Use of Water®

We believe it is our responsibility at Rain Bird to develop products that use water efficiently.

ESP-Me Controller Features

Feature	Description
Maximum Stations	22 (with optional Station Modules)
Master Valve or Pump Start Relay	Supported
Start Times	6
Programs	4
Program Cycles	Custom Days, Odd, Even and Cyclic
Permanent Days Off	Supported
Master Valve Control	On/Off per station
Rain Delay	Supported
Rain/Freeze Sensor	Supported
Sensor Bypass	By station
Seasonal Adjust	Global or by program
Manual Station Run	Yes
Manual Program Run	Yes
Manual Test All Stations	Yes
Short Detect	Yes
Delay Between Stations	Yes
Accessory Port	Yes (5 pin)
Save & Restore Programming	Yes
WiFi Enabled	Yes

WiFi Enabled

The LNK WiFi Module allows remote connection to a Rain Bird ESP-Me Controller using an Apple iOS or Android compatible smart device. The mobile application allows remote access and configuration of one or more irrigation controllers.

For more information on the LNK WiFi Module and the value this product can provide for your ESP-Me controller, please visit: <http://wifi-pro.rainbird.com>

LNK WiFi Module (sold separately)

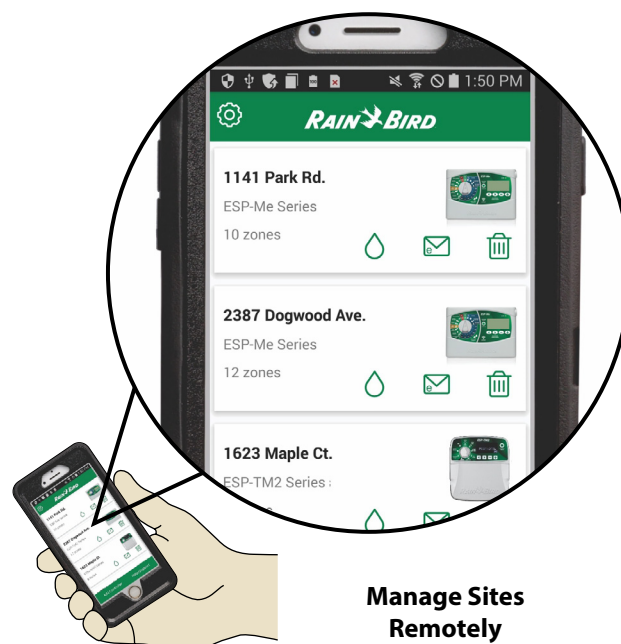

Manage Sites Remotely

Installation

Mount Controller

- 1 Drive a mounting screw into the wall, leaving an 1/8 inch gap between the screw head and the wall surface (use the supplied wall anchors if necessary), as shown.
- 2 Locate the keyhole slot on back of the controller unit and hang it securely on the mounting screw.

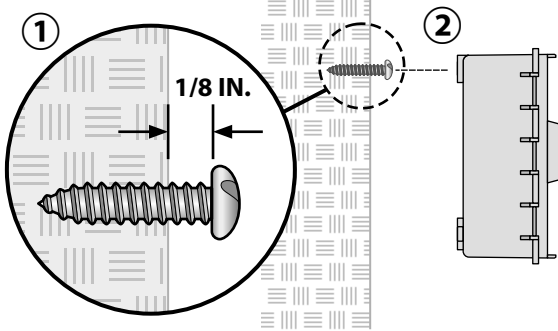

- 3 Open the front panel, and drive three additional screws through the open holes inside the controller and into the wall, as shown.

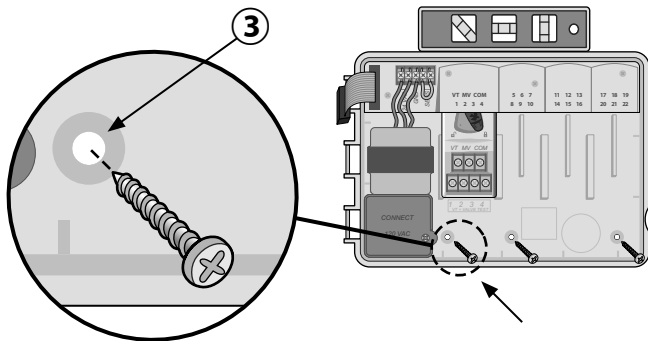

Wiring Connections

Connect Valves

- 1 Route all field wires through the opening at the bottom or back of the unit. Attach conduit if desired, as shown.
- ⚠️ WARNING:** Do not route the valve wires through the same opening as the power wiring.
- 2 Connect one wire from each valve to the terminal on the base module or Station Module that corresponds to the desired station number (1-22).
 - 3 Connect a field common wire (C) to the common terminal (C) on the base module. Then connect the remaining wire from each valve to the field common wire, as shown.
 - 4 To perform a Valve Test, connect the common wire to the "COM" terminal and the power wire to the "VT" terminal. This will immediately turn the valve "ON".

Connect Master Valve (optional)

- 5 Connect a wire from the master valve to the master valve terminal (MV) on the base module. Then connect the remaining wire from the master valve to the field common wire, as shown.

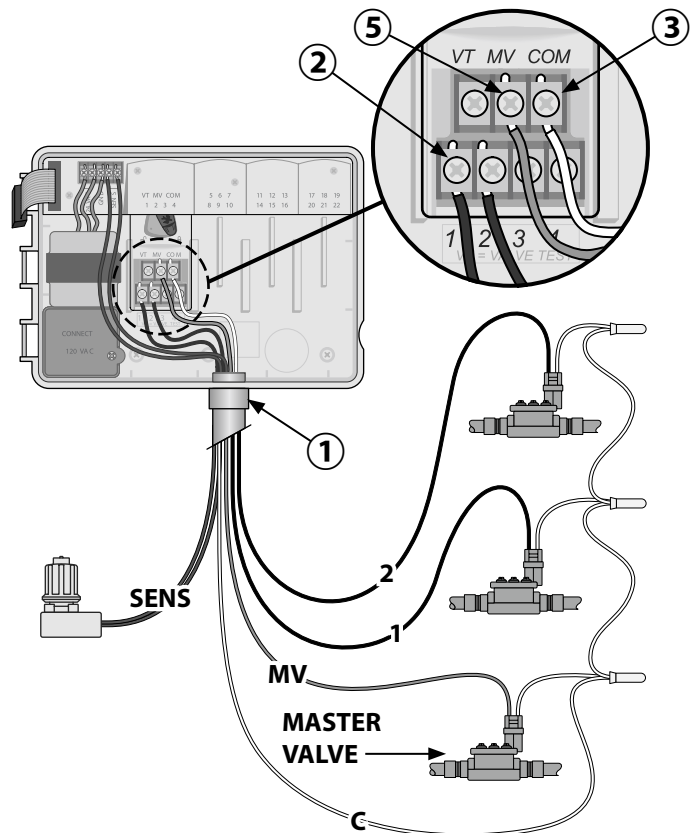

Connect Pump Start Relay (optional)

The ESP-Me can control a pump start relay, to turn the pump on and off as needed.

- ① Connect a wire from the pump start relay (PSR) to the master valve terminal (MV) on the base module. Then connect another wire from the pump start relay to the field common wire, as shown.
- ② To avoid the possibility of damage to the pump, connect a short jumper wire from any unused terminal(s) to the nearest terminal in use, as shown.

! **NOTE:** The ESP-Me controller DOES NOT provide power for a pump. The relay must be wired according to manufacturer instructions.

Only the following Rain Bird pump start relay models are compatible with the ESP-Me:

Description	Note	Model No.
Universal Pump Relay	110 volt only	PSR110IC
Universal Pump Relay	220 volt only	PSR220IC
Dual Pole Pump Relay	110/120 volt	PSR110220

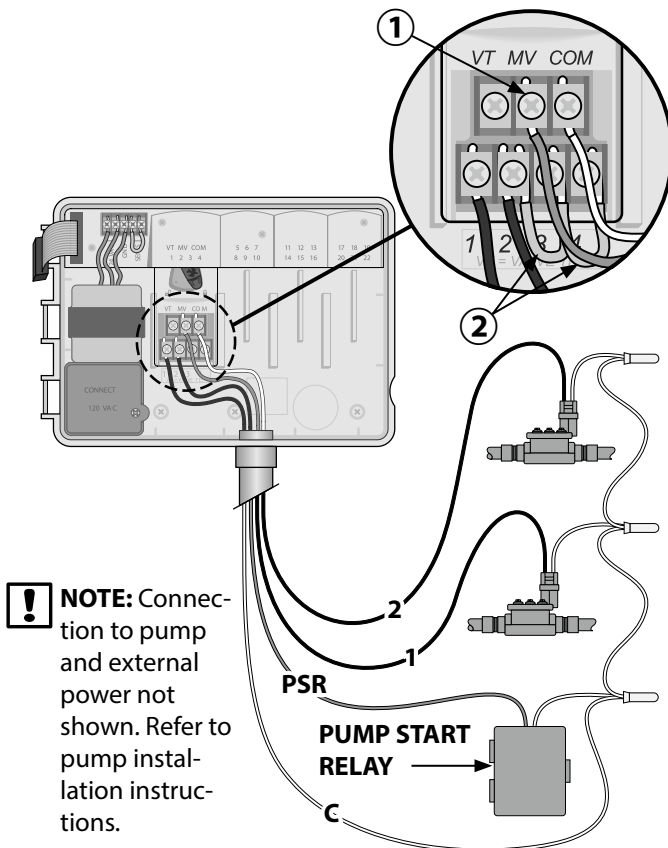

Connect Rain/Freeze Sensor (optional)

The ESP-Me controller can be set to obey or ignore a rain sensor. Refer to the Rain Sensor section under Advanced Programming.

- ① Remove the yellow jumper wire from the SENS terminals on the controller.
- !** **NOTE:** Do not remove the yellow jumper wire unless connecting a rain sensor.
- ② Connect both rain sensor wires to the SENS terminals, as shown.

⚡ **WARNING:** Do not route the rain sensor wires through the same opening as the power wiring.

! **NOTE:** Rain Bird controllers are only compatible with normally closed rain sensors.

! **NOTE:** For wireless rain/freeze sensors, refer to installation instructions for sensor.

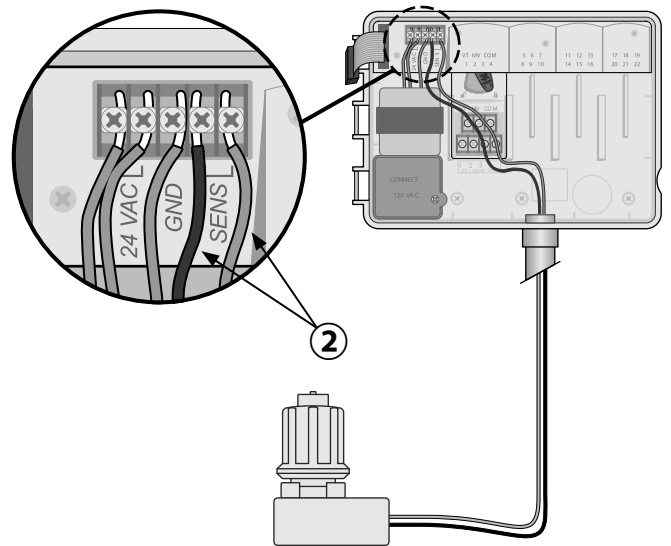

Connect Power

⚡ WARNING: DO NOT plug in the transformer or connect external power until you have completed and checked all wiring connections.

⚡ WARNING: Electric shock can cause severe injury or death. Make sure power supply is turned OFF before connecting power wires.

Indoor Model

① Route the transformer power cord through the conduit opening at the bottom left of the unit. Knot the cable/cord inside the controller cabinet to prevent it from being pulled out.

⚡ WARNING: Do not route the power cord through the field wire opening at the bottom right of the unit.

② Connect the two power wires on the cord to the two 24VAC terminal connections on the controller.

③ Connect the ground wire on the cord to the GND terminal.

④ Plug the transformer into an electrical outlet.

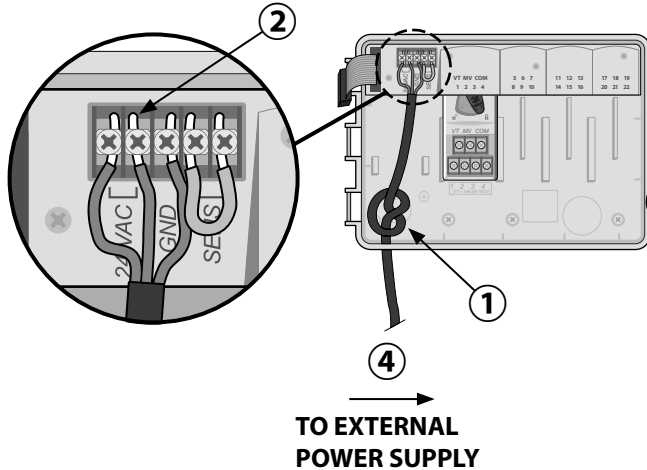

Outdoor Model

Power Wiring Connections

Black supply wire (hot) to the black transformer wire

White supply wire (neutral) to the white transformer wire

Green supply wire (ground) to the green transformer wire

① Locate the transformer wiring compartment in the lower left corner of the controller unit. Use a screwdriver to remove the cover and expose the transformer connection wires.

② Route the three external power source wires through the conduit opening at the bottom of the unit and into the wiring compartment.

③ Using the provided wire nuts, connect the external power source wires (two power and one ground) to the transformer connection wires inside the wiring compartment.

⚡ WARNING: Ground wire must be connected to provide electrical surge protection. Permanently mounted conduit shall be used for connecting main voltage to the controller.

④ Verify that all wiring connections are secure, then replace the wiring compartment cover and secure it with the screw.

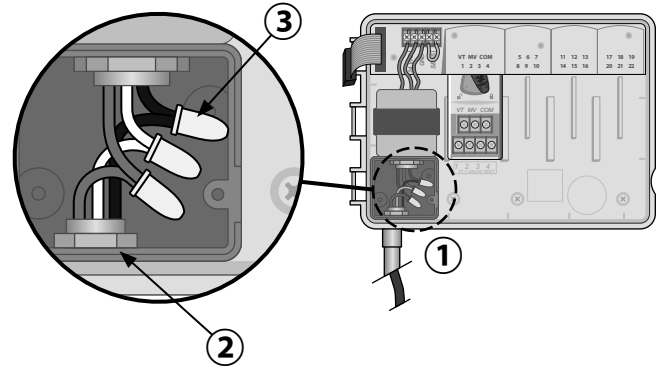

Station Expansion Modules

Optional Station Modules are installed in the empty slots to the right of the base module to increase the station capacity up to 22 stations.

! **NOTE:** 6-Station module is compatible only with the ESP-Me. They are not backwards compatible with the previous ESP-M vintage controller.

! **NOTE:** For ideal station sequencing, it is recommended that a 6-Station module always be installed in Bay 2. For more details see the Station Numbering section.

Base Module
(included)



Expansion Modules
(sold separately)

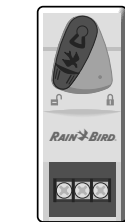

3-STATION
(ESP-M3)



6-STATION
(ESP-M6)

Install Modules

- ① Verify the securing lever on the module is in the unlocked position (slide to the left).
- ② Place the module under the desired slot between the plastic rails.
- ③ Push the module up into the slot until secure.
- ④ Slide the securing lever to the locked position (slide to the right).

🔄 **REPEAT** for additional modules.

! **NOTE:** Modules can be installed or removed with OR without AC power connected. They are considered “hot-swappable”.

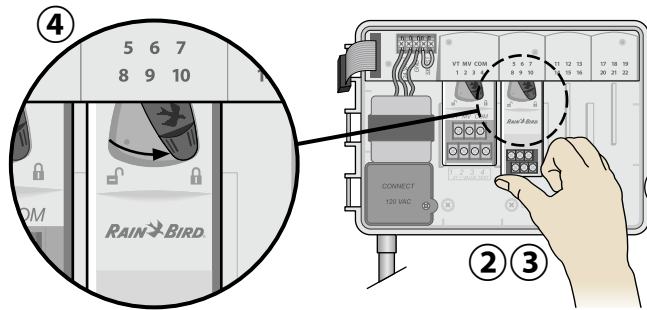

Station Numbering

Fixed Station Numbering Description

The controller is configured with **Fixed Station Numbering**. Each bay is set up to accept a 6 station module and reserve the station number for future use if a 6 station module is NOT installed in Bays 2, 3 or 4.

Station numbers are pre-assigned as follows:

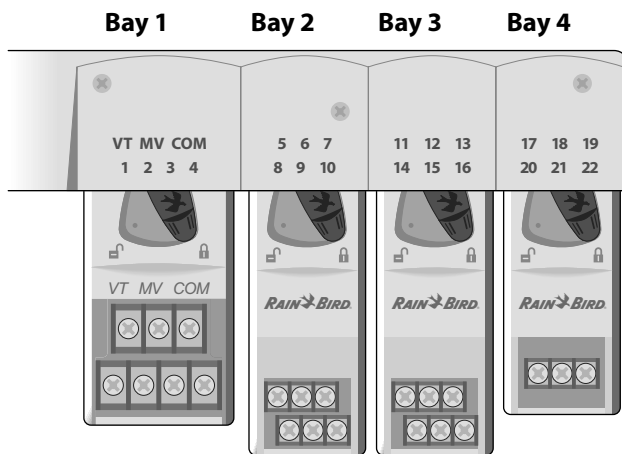

Example Of Recommended Installation For 19 Stations

Module Configuration

Example of installation with station numbering gaps:

- A total of 19 stations are installed.
- The Base Module is installed in Bay 1 and uses Stations 1 through 4.
- A 6-Station Expansion Module is installed in Bays 2 and 3 using Stations 5 through 16.
- A 3-Station module is installed in Bay 4 and uses stations numbered 17 through 19.

Because a 3-Station module is installed in Bay 4, only the first three station numbers assigned to that bay will be used and the unused numbers will be “reserved” for future use.

! **NOTE:** During programming, the controller will skip any unused station numbers, creating a gap in station numbering.

As an example: a 3-Station module was installed in Bay 4, so stations 20-22 will be unavailable for programming. During programming the missing stations will show on the display as 20SKIP, 21SKIP, etc.



The screen displays “20SKIP” with the “20” flashing to indicate that Station 20 (and also 21-22) are unused and unavailable for programming.

Complete Controller Installation

- ① Reinstall and reconnect the front panel.
- ② Apply power to the controller and test the system.

! **NOTE:** The electrical connections can be checked even if water is not available. If water is available and you would like to test some or all of your stations, use the Test All Stations feature of the controller.

Normal Operation

Controls and Indicators

Key operational features of the ESP-Me Controller:

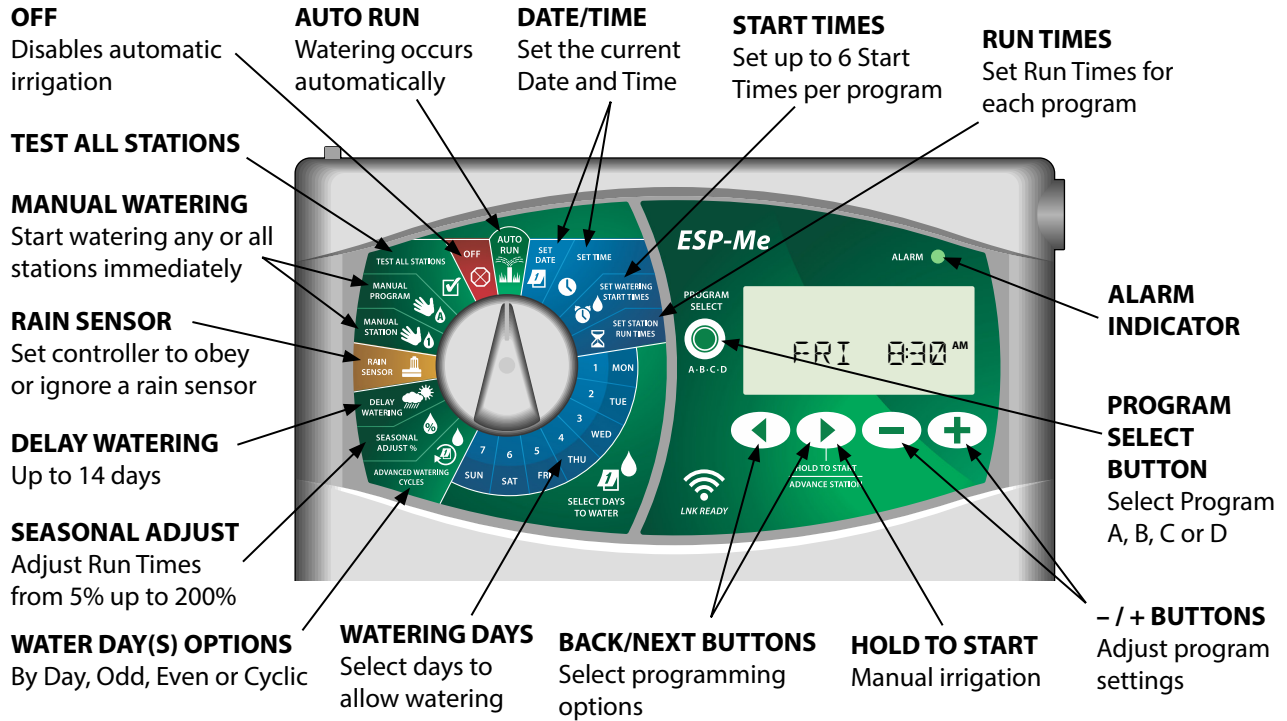

AUTO RUN

AUTO RUN is the normal operating mode. Return the dial to AUTO RUN when programming is complete..

During Watering:

The display shows a blinking sprinkler symbol, the active Station Number or Program, and the Remaining Run Time.

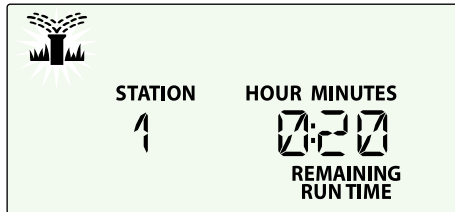

- To cancel watering, turn the dial to **OFF** for three seconds until the screen shows OFF.

To Manually Start a Program:

- 1 Press the **PROGRAM SELECT** button to select a program.
- 2 Press the **HOLD TO START** button to immediately run the displayed program.

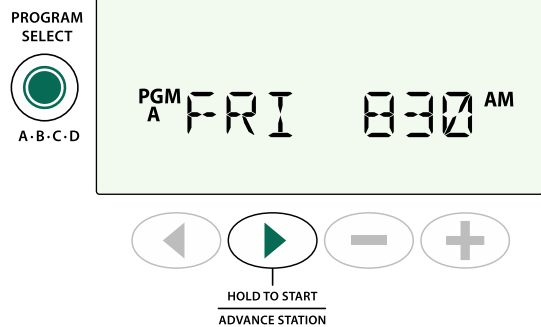

OFF

Turn the dial to **OFF** to stop automatic irrigation or to cancel all active watering immediately.

CAUTION: Watering will NOT occur if the controller remains in OFF.

Program-Based Scheduling

The ESP-Me uses a programmed-based scheduling method to create irrigation schedules.

For each Program (A, B, C and D):

- ① Select Watering Days (Custom, Odd/Even, Cyclic) and Start Times that apply globally to the entire program.
- ② Assign a Run Time to each available station number to run during the selected program.

Program Stacking

If any programs have Start Times that overlap, the ESP-Me will “stack” the Start Times. When all Stations have run in Program A, then Program B will start watering. Individual stations will water in sequential order.

As an example: Program A and B are both set to start at 8:00 AM. But Program B will not run until Program A is finished.

With **Program Stacking**, Program B only starts when Program A is finished

Program	START	Station	Scheduled Start	Actual Start	Run Times			
A	1 st	1	8:00 AM	8:00 AM	30 MIN			
		2		8:30 AM		30 MIN		
		3		9:00 AM			30 MIN	
		4		9:30 AM				30 MIN
B	1 st	5	8:00 AM	10:00 AM	30 MIN			
		6		10:30 AM		30 MIN		
		7		11:00 AM			30 MIN	
		8		11:30 AM				30 MIN

Common Programming Error

The most common programming error for any program-based controller is multiple Program Start Times that cause watering cycles to repeat.

As an example: Program A has a 1st Start Time set to run at 8:00 AM. With program stacking, each Station will run in order, until all zones are watered. There’s no need to set each Station to run separately.

In this example, a 2nd Start Time has mistakenly been set for 8:30 AM, which means that some zones would be watered twice that morning.

NOTE: Only assign Run Times in a Program for stations you want to water. If you do not want a specific station to run in a selected program then set the Run Time to zero.

Multiple Start Times cause Stations to water repeatedly.

To fix, **remove** the additional 2nd Start Time

Program	START	Station	Scheduled Start	Actual Start	Run Times			
A	1 st	1	8:00 AM	8:00 AM	30 MIN			
		2		8:30 AM		30 MIN		
		3		9:00 AM			30 MIN	
		4		9:30 AM				30 MIN
A	2 nd	1	8:30 AM	10:00 AM	30 MIN			
		2		10:30 AM		30 MIN		
		3		11:00 AM			30 MIN	
		4		11:30 AM				30 MIN

Basic Programming

1. Set Date and Time

-  Turn the dial to **SET DATE**
- 1 Press ◀ or ▶ to select the setting to change.
 - 2 Press – or + to change the setting value.
 - 3 Press and hold – or + to accelerate adjustments.

-  Turn the dial to **SET TIME**.
- 1 Press ◀ or ▶ to select the setting to change.
 - 2 Press – or + to change the setting value.
 - 3 Press and hold – or + to accelerate adjustments.

To change the time format (12 hour or 24 hour):

- 1 With **MINUTES** blinking, press ▶.
- 2 Press – or + to select the desired time format, then press ▶ to return to the time setting.

2. Set Watering Start Times

Up to six Start Times are available for each program.

-  Turn the dial to **SET WATERING START TIMES**
- 1 Press **PROGRAM SELECT** to choose the desired Program (if necessary).
 - 2 Press ◀ or ▶ to select an available Start Time.
 - 3 Press – or + to set the selected Start Time (ensure the AM/PM setting is correct).
 - 4 Press ▶ to set additional Start Times.

 **NOTE:** The OFF Position for any start time is between 11:45 PM and 12:00 AM.

3. Set Station Run Times



Run Times can be set from one minute up to six hours.

-  Turn the dial to **SET STATION RUN TIMES**
- 1 Press **PROGRAM SELECT** to choose the desired Program (if necessary).
 - 2 Press ◀ or ▶ to select a Station.
 - 3 Press – or + to set the Run Time for the selected Station.
 - 4 Press ▶ to set additional Station Run Times.

4. Set Watering Days

Custom Days of the Week



Set watering to occur on specific days of the week.

-  Turn the dial to **ADVANCED WATERING CYCLES**
- 1 Press **PROGRAM SELECT** to choose the desired Program (if necessary).
 - 2 Press – or + to select **BY DAY**.
 - 3 Turn the dial to **MON**.
 - 4 Press – or + to set the selected (blinking) day as either **ON** or **OFF**, then turn the dial to the next day of the week.
-  **REPEAT** to select additional days as desired for the selected program.

Manual Watering Options

Test All Stations

Verify operation of valves in the system.

-  Turn the dial to **TEST ALL STATIONS**.
- 1 Press – or + to set a Run Time.
 - 2 Press the **HOLD TO START**  button.
 - 3 Turn the dial to **AUTO RUN** after display shows **TESTING**.

During Testing:

The display shows a blinking sprinkler symbol, the active Station Number or Program, and the Remaining Run Time.

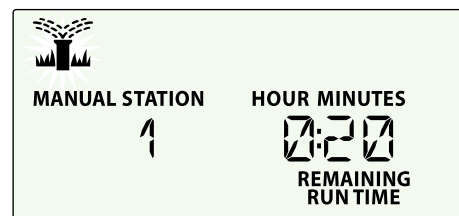

- 4 To cancel the test, turn the dial to **OFF** for three seconds until the screen shows OFF.

Run a Single Station

Start watering immediately for a single station.



Turn the dial to **MANUAL STATION**.



- 1 Press ◀ or ▶ to select a Station.
- 2 Press — or + to set a Run Time.
- 3 Press the **HOLD TO START** (▶) button.
- 4 Irrigation will begin and “**STARTED**” will appear on the display.

Run a Single Program

Start watering immediately for one program.



Turn the dial to **MANUAL PROGRAM**.

- 1 Press **PROGRAM SELECT** to choose the desired Program (if necessary). The total run time for the program is displayed.
 - 2 Press the **HOLD TO START** (▶) button to begin watering start the selected Program.
-  **REPEAT** as desired to queue additional programs to run manually.
-  **NOTE:** A maximum of 38 stations can be queued across all four programs.
- 3 Irrigation will begin and “**STARTED**” will appear on the display.
 - 4 Press the **ADVANCE STATION** (▶) button to advance to the next station if desired.

During Manual Watering (Single Station or Single Program):

The display shows a blinking sprinkler symbol, the active Station Number or Program, and the Remaining Run Time.

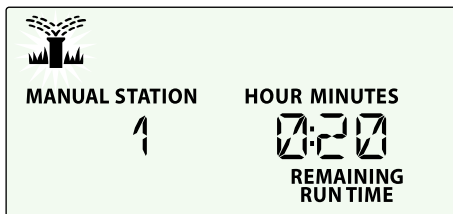

- To cancel manual watering, turn the dial to **OFF** for three seconds until the screen shows OFF.

Advanced Programming

Odd or Even Calendar Days

Set watering to occur on all ODD or EVEN calendar days.



Turn the dial to **ADVANCED WATERING CYCLES**

- 1 Press **PROGRAM SELECT** to choose the desired Program (if necessary).
 - 2 Press — or + to select **ODD** or **EVEN**.
-  **NOTE:** ODD or EVEN is displayed when the dial is turned to any day of the week position.

Cyclic Days

Set watering to occur at specific intervals, such as every 2 days, or every 3 days, etc.



Turn the dial to **ADVANCED WATERING CYCLES**.

- 1 Press **PROGRAM SELECT** to choose the desired Program (if necessary).
- 2 Press — or + to select **CYCLIC**, then press ▶
- 3 Press — or + to set the desired **DAY CYCLE**, then press ▶
- 4 Press — or + to set the **DAYS REMAINING** before the cycle begins. The **NEXT** watering day updates on the display to indicate the day that watering will start as shown.

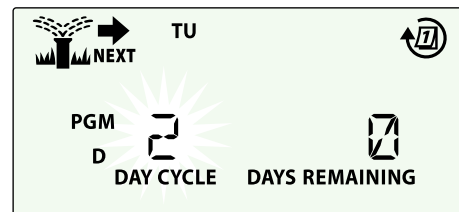

Rain Sensor

Set the controller to obey or ignore a rain sensor.

When set to **ACTIVE**, automatic irrigation will be suspended if rainfall is detected. When set to **BYPASS** all programs will ignore the rain sensor.



Turn the dial to **RAIN SENSOR**.

- Press **-** or **+** to select **ACTIVE** (obey) or **BYPASS** (ignore).

Legend	Rain Sensor Icon Status
	Active
	Bypassed
	Rain detected

NOTE: See **Special Features** to set Rain Sensor Bypass by Station.

Seasonal Adjust

Increase or decrease program run times by a selected percentage (5% to 200%).

As an example: If the Seasonal Adjust is set to 100% and the station Run Time is programmed for 10 minutes, the station will run for 10 minutes. If the Seasonal Adjust is set to 50%, the station will run for 5 minutes.



Turn the dial to **SEASONAL ADJUST**.

- 1 Press **-** or **+** to increase or decrease the global percentage setting.
- 2 To adjust an individual Program, press **PROGRAM SELECT** to choose the desired Program (if necessary).

Delay Watering

Suspend watering for up to 14 days.



Turn the dial to **DELAY WATERING**.

- 1 Press **-** or **+** to set the **DAYS REMAINING**. The **NEXT** watering day will update on the display to indicate when watering will resume.



- 2 To cancel a Rain Delay, set the **DAYS REMAINING** back to 0.



NOTE: When the delay expires, automatic irrigation resumes as scheduled.

Permanent Days Off

Prevent watering on selected days of the week (for Odd, Even or Cyclic programming only).



Turn the dial to **1 MON** (or any desired day)

- 1 Press **PROGRAM SELECT** to choose the desired Program (if necessary).
- 2 Press and **HOLD** both **◀** and **▶** at the same time until the Permanent Days Off screen is displayed.
- 3 Press **-** to set the selected (blinking) day as a Permanent Day Off or press **+** to leave the day **ON**.



Total Run Time Calculator By Program

View the *Total Run Time for an entire program.*

The controller can determine the Total Run Time of a program by adding up all the Run Times for each station in that program.



Turn the dial to **MANUAL PROGRAM**.

- 1 The Total Run Time for **PGM A** is displayed.



- 2 Press the **PROGRAM SELECT** button to view the Total Run Time for the next program.

NOTE: The run time displayed for each program is the seasonally adjusted run time and only includes one start time.

Special Features

- 1 Turn the dial to the desired position indicated below for each Special Feature.
- 2 Press and hold ◀ and ▶ at the same time.

SAVE PROGRAMS

BYPASS RAIN SENSOR FOR ANY STATION

Tells an individual station to obey or ignore a rain sensor.

RESET TO FACTORY DEFAULTS

All programmed schedules will be erased.

RESTORE SAVED PROGRAMS

PERMANENT DAYS OFF

Prevent watering on selected days of the week.

SET MASTER VALVE BY STATION

Allows a station to be controlled by a master valve or pump start relay.

DELAY BETWEEN VALVES

A station delay (from 1 second to 9 hours) ensures that a valve has completely closed before the next one opens.

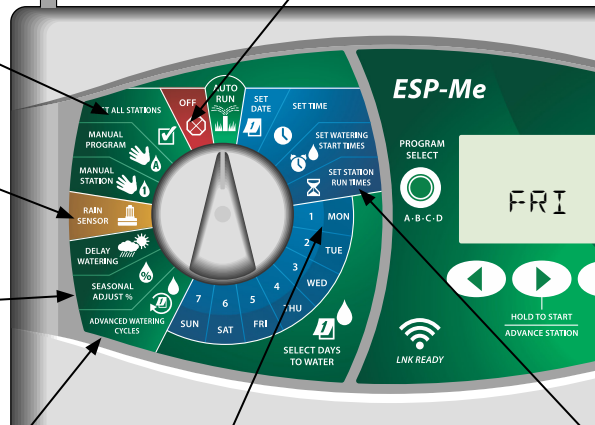

Options

Reset Button

If the controller is not working properly, you can try pressing RESET.

- Insert a small tool such as a paper clip, into the access hole and press until the controller is reset. All previously programmed watering schedules will remain stored in memory.

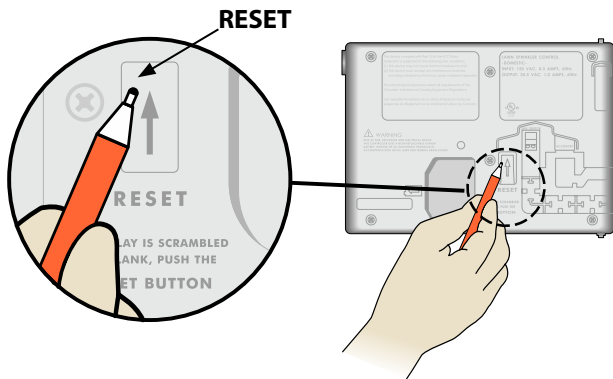

Remote Accessories

A 5 pin accessory port is available for Rain Bird approved external devices, including:

- LNK WiFi Module
- LIMR Receiver Quick Connect harness

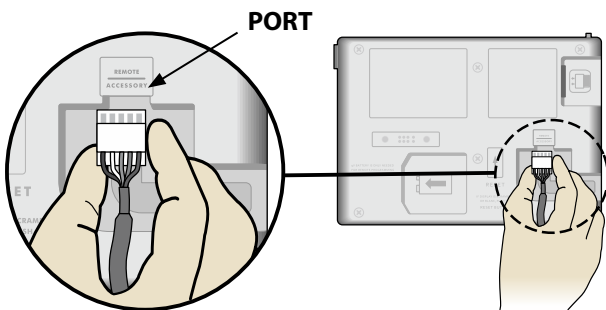

Remote Programming

Program the front panel remotely on battery power.

The front panel can be removed from the controller and programmed remotely using a 9 volt battery for power. Settings can be programmed for all 22 stations regardless of which station modules are installed in the controller.

! **NOTE:** This is useful if a contractor wants to program the controller prior to installation on site.

- 1 Remove the front panel.
- 2 Install a 9V battery in the battery compartment.
- 3 Program the controller.

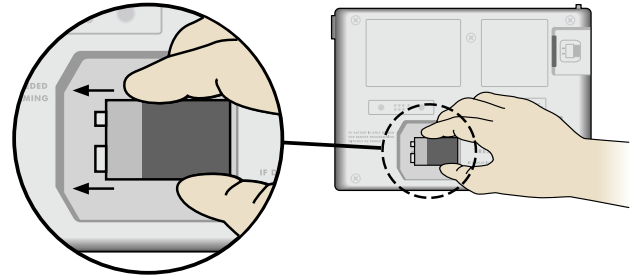

! **NOTE:** Program information is stored in nonvolatile memory so it is never lost if the front panel loses power.

- 4 Replace the front panel (refer to Complete Installation in the Installation section).

! **NOTE:** After the front panel is re-installed, any station that does not have a corresponding Station Module installed will function as though the run time is zero.

Battery Life

If the display repeatedly shows “-----” when using a 9V battery for remote programming, replace the battery.

Troubleshooting

Error Detection

The ESP-Me controller has built-in error detection that can automatically generate an ALARM caused by an essential programming error or if an electrical short condition is detected.

The ALARM LED light on the ESP-Me controller front panel will light up to indicate an alarm condition:

Programming Errors (blinking LED)

Error	ALARM LED	Error Message On Display
No Start Times are set	BLINK	NO START TIMES
No Run Times are set	BLINK	NO RUN TIMES
No Watering Days are set	BLINK	NO WATER DAYS

The ESP-Me controller will reset or clear when the error is corrected.

! **NOTE:** The dial must be in the **AUTO RUN** position for an ALARM message to appear on the display.

Electrical Errors (non-blinking LED)

Error	ALARM LED	Error Message On Display
Master Valve short	SOLID	MASTER VALVE/PUMP WIRE SHORTED OR HIGH CURRENT
Station short	SOLID	STATION "X" WIRE SHORTED

When an electrical error is detected, irrigation for the affected station is cancelled and watering advances to the next operable station in the program.

The controller will attempt to water the affected station again at the next scheduled watering. Completion of a successful watering will clear the error condition associated with that station.



Clearing Electrical Error Alarms

Turn the dial to the **AUTO RUN** position to view the error message on the display. To clear the ALARM, press the right arrow button.

Watering Issues

Problem	Possible Cause	Possible Solution
Display shows a program is active, but system isn't watering.	Water source not supplying water.	Verify there is no disruption to the main water line and that all other water supply lines are open and functioning properly.
	Wiring is loose or not properly connected.	Check that field wiring and master valve or pump start relay wiring is securely connected at the controller and in the field.
	Field wires are corroded or damaged.	Check field wiring for damage and replace if necessary. Check wiring connections and replace with watertight splice connectors if needed.
	Loss of AC power.	When there is a power loss and a 9 volt battery is installed, the system does not irrigate but programs show as remaining active.
NO AC message on display.	No Power detected.	Check circuit breaker and that unit is plugged into socket or properly connected to power source.
	Controller may be plugged into a GFI outlet or an outlet that is wired to a GFI outlet.	Check power to the outlet or reset the circuit breaker.
It just rained and the alarm light is not illuminated, why?	This is normal operation. The ESP-Me does not consider the interruption of irrigation due to rainfall an alarm condition.	This is normal operation.

Watering Issues

Problem	Possible Cause	Possible Solution
Programmed schedules do not start.	Connected rain sensor may be activated.	Set Rain Sensor to BYPASS to ignore the rain sensor. If watering resumes, the sensor is operating properly and no further correction is needed.
	Connected rain sensor may not be operating properly.	Let the rain sensor dry out, or disconnect it from the controller terminal strip and replace it with a jumper wire connecting the two SENS terminals, or set to Bypass.
	If no rain sensor is connected, the jumper wire connecting the two SENS terminals on the terminal strip may be missing or damaged.	Move dial position to Sensor Bypass and set to Bypass.
Too much irrigation	Multiple Start Times in the same program.	Turn off any additional Start Times that are causing watering cycles to repeat (the Start Time OFF position is between 11:45 and 12:00). See "Program Stacking" on page 7 for more information.
	Multiple programs are running at the same time.	Review programming to assure that the same Station is not active in multiple Programs.
	Valve is malfunctioning.	Check to see if the ALARM light on the controller is lit solid, then repair or replace the valve if necessary.
	Seasonal Adjust setting is too high.	Set Seasonal Adjust to 100%.

Electrical Issues (solid LED illuminated)

Problem	Possible Cause	Possible Solution
Display is blank or frozen, the controller will not accept programming or is operating abnormally.	Power not reaching the controller.	Verify the main AC power supply is securely plugged in or connected and working properly.
	Controller needs to be reset.	Press the Reset Button. For details see "Reset Button" section.
	An electrical surge may have interfered with the controller's electronics.	Unplug the controller for 2 minutes, then plug it back in. If there is no permanent damage, the controller should accept programming and resume normal operation.
Automatic error detection indicates a problem by ALARM LED and an error message on display.	Short circuit or overload condition in valve, master valve or pump start relay wiring.	Identify and repair the fault in the wiring. Refer to compatible pump start relays. For details see "Connect Pump Start Relay" section.
LED is flashing or solidly illuminated but I see no message on the LCD.	Dial not in AUTO RUN position.	Turn dial to AUTO RUN position.

Safety Information

CAUTION: This appliance is not intended for use by persons (including children) with reduced physical, sensory or mental capacity, or lack of experience and knowledge unless they have been given supervision or instruction concerning use of the appliance by a person responsible for their safety. Children should be supervised to ensure that they do not play with the appliance.



WARNING: Special precautions must be taken when valve wires (also known as station or solenoid wires) are located adjacent to, or share a conduit with other wires, such as those used for landscape lighting, other “low voltage” systems or other “high voltage” power.

Separate and insulate all conductors carefully, taking care not to damage wire insulation during installation. An electrical “short” (contact) between the valve wires and another power source can damage the controller and create a fire hazard.



WARNING: All electrical connections and wiring runs must comply with local building codes. Some local codes require that only a licensed or certified electrician can install power. Only professional personnel should install the controller. Check your local building codes for guidance.



NOTE: Date and time are retained by a lithium battery which must be disposed of in accordance with local regulations.

CAUTION: Use only Rain Bird approved accessory devices. Unapproved devices may damage the controller and void warranty. For a list of compatible devices go to: www.rainbird.com

FCC Part 15

This equipment has been tested and found to comply with the limits for a Class B digital device, pursuant to Part 15 of the FCC Rules. These limits are designed to provide reasonable protection against harmful interference in a residential installation.

This equipment generates, uses, and can radiate radio frequency energy and, if not installed and used in accordance with the instructions, may cause harmful interference to radio communications. However, there is no guarantee that interference will not occur in a particular installation.

If the equipment does cause harmful interference to radio or television reception, which can be determined by turning the equipment off and on, the user is encouraged to try to correct the interference by the following measures:

- Reorient or relocate the receiving antenna.
- Increase the separation between the equipment and receiver.
- Connect the equipment into an outlet on a circuit different from that to which the receiver is connected.
- Consult the dealer or an experienced radio/TV technician for help.
- Changes or modifications not expressly approved by Rain Bird Corporation could void the user's authority to operate the equipment.
- This product was FCC certified under test conditions that included the use of shielded I/O cables and connectors between system components. To be in compliance with FCC regulations, the user must use shielded cables and connectors and install them properly.
- This class B digital apparatus meets all requirements of the Canadian Interference Causing Equipment Regulations.

Cet appareil Numérique de la classe B respecte toutes les exigences du Règlement sur le matériel brouilleur du Canada